



Electric Oral Anesthesia Injector

Mini I(Smart I) User Manua



SGEOAI2020-1.0

Table of Contents

1. Introduction.....	2
2. Product Description	2
3. Indications for Use	2
4. Package Contents.....	2
5. Features and Benefits.....	3
6. Specifications.....	3
7. Operating Procedure.....	4
8. Changing the O-Ring.....	7
9. Attention / Caution.....	8
10.FCC Caution	9
11. Device Label.....	9
12. Label Symbols Defined	9
13. Prevention ofCross-Contamination	10
14. Troubleshooting.....	10
15. Manufacturer Warranty, Service and Support.....	10
16.Magnetic compatibility information.....	11



Shenzhen Soga Medical Equipment Co., Ltd.

1. Introduction

The Mini I(Smart I) Electric Oral Anesthesia Injector is a professional and painless local anesthesia injection device used for the oral cavity.

Mini I(Smart I)Electric Oral Anesthesia Injector can play the role of automatic injection of anesthetics under the circumstances of block conduction anesthesia, local infiltration anesthesia and periodontal membrane local anesthesia in stomatology department.

Primacaine, Scandonest and other major anesthetics for the oral cavity.

2. Product Description

The Mini I(Smart I) Electric Oral Anesthesia Injector is a device used for injecting local anesthetic prior to, or in conjunction with, dental procedures. The method used to deliver the anesthetic to the patient allows the use of less anesthetic and the onset of the anesthesia is often faster. The needle is not what causes the discomfort of an injection to the patient, it's the flow of the anesthetic or the rate of delivery to the tissue.

3. Indications for Use

The Mini I(Smart I) Electric Oral Anesthesia Injector is a device used for the injection of local anesthetics for anesthesia administered prior to, or in conjunction with, dental procedures.

4. Package Contents

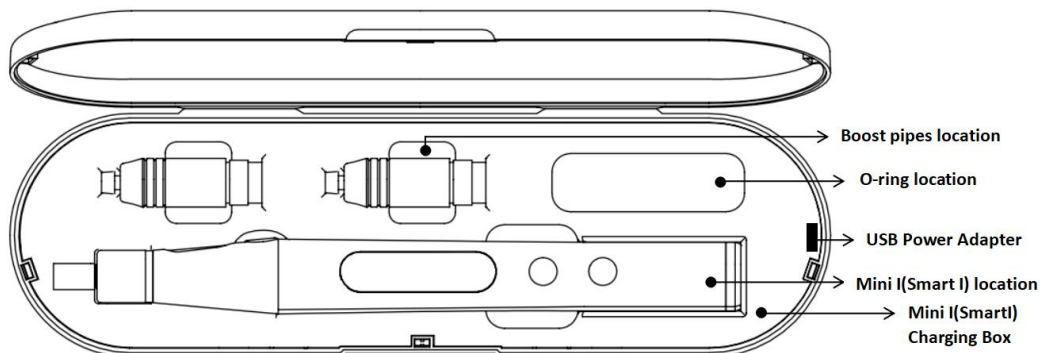

- One handpiece with controls and display screen
- Two boost pipes; disinfect with autoclave before use
- One charging base
- One power adapter

- One charging cable
- O-ring, 10 pieces. Set the o-ring in the front part of plunger. When suctioned back, the o-ring will produce a negative pressure on the anesthetic tube.
- Disposable sleeve, 50 pie

5. Features and Benefits

1. Save on anesthetic and lower costs, with no pipeline or other consumables.
2. Simple operation, with one finger touching the controls of the pen-like handpiece. There is no foot switch.
3. Low noise with music.
4. LCD screen shows the operating process and dosage.
5. No-contact battery induction charging.
6. Audio alarm

6. Specifications

- 1.Type classification of electric shock protection: internal electric source. IEC standard 60601 type BF.
2. Water resistance grade IPX 0. Keep dry.
3. Working system: continuous operation
4. No signal inputs
5. No signal outputs
6. No vibration prevention or cancellation
- 7.Non AP/APG type
8. Working environment: the equipment is applied in the general office environment.
9. Power adapter input: AC 100-240V 50/60Hz Output: 5V DC.
10. Working power: built-in lithium battery charging.
11. Working voltage: DC 3.7V.
12. Working current: 100mA.
13. Working indication: LED flicker indicating.

7. Operating Procedure



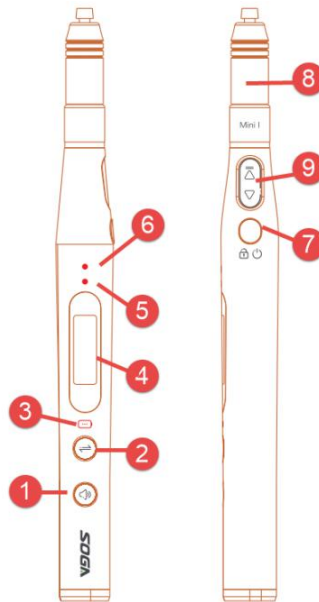

7.1 Product indication and key function



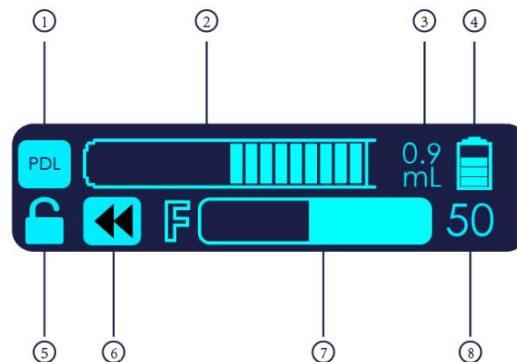

Serial number	Name	Function description
1	Music settings key	After long press to enter the setting state, click to adjust the music sound
2	Injection mode setting key	After the long press to enter the set state, click to switch to speed mode
3	Charge Indicating Lamp	It is used to indicate the charging state. Green flashes when charging normally
4	OLED Display Screen OLED	Used to display working status and instructions
5	Work Indicating Lamp	Indicate that the push rod is working, flashing when working normally
6	Caution Indicating Lamp	It is used to indicate that the injection site is periodontal membrane or the injection is finished, and it lights up when prompted
7	Power / switch key	Long press is used to switch on and off the machine, short press is used to unlock and lock
8	Booster tube	Used to fix local anesthetic bottle
9	Start work key	Touch the area with your finger to get the push rod to work, Raise your hand and suck back

7.2 OLED screen description



Serial number	Name	Screen description
1	Injection mode	<p>Displays the current injection mode status. There are three injection modes:</p> <ol style="list-style-type: none">  Periodontal membrane pattern  Fast mode  Slow mode
2	Anesthesia injection progress bar	Show current anesthetic injection progress
3	Number of anesthetics injected	Display the number of anesthetics that have been injected
4	Electric quantity	Display current power
5	Safety lock	<p>Displays the status of the current safety lock. There are two modes:</p> <ol style="list-style-type: none">  Locked status: locked means "start to touch" is not operable.  Unlocking status: unlocking means "start touch key" can be operated.

6	Injection of state	Displays the current infusion status. There are two status displays
		1.  Forward injection state
		2.  Suck back state
7	Injection pressure status	Display current injection pressure
8	Injection pressure value	Display the current injection pressure value

7.3 Specific operation method

Install Boost Pipe and needle:

Remove the protective cap from the front of the needle, taking care to protect yourself.

First put (card type) special local anaesthetic and needle into the Boost Pipe, then insert the Boost Pipe into the main body. Rotate to the right (clockwise) to install; Rotate left (counterclockwise) to unload. As shown in the figure below:

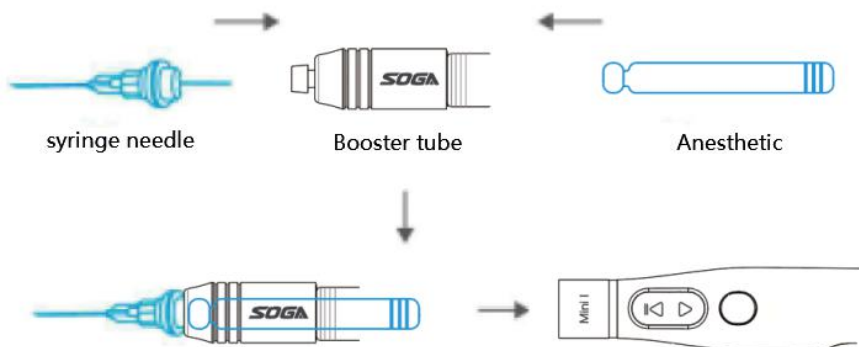

① **starting up :**

Long press Power/switch key for 3S or more, the screen lights up and enters standby state.

② **Enter the parameter adjustment setting state:**

After booting up, click Power/switch key to select the appropriate speed mode.

Long press the Injection mode setting key to select the forward direction of the putter.

Velocity in different modes	
Mode	Flow rate and flow rate accuracy at 1.8ml injection volume
PDL	0.42mL/min, deviation $\pm 10\%$
Slow mode (S)	1.02mL/min, deviation $\pm 10\%$
Fast mode (H)	1.62mL/min, deviation $\pm 10\%$

③ **Enter ready state:**

Click the Injection mode setting key to change the state of the lock to make it ready.

④ **Start-up:**

In the preparation state, touch the Start work key area with fingers to make its push rod start to work and drain off the air in the needle, at this time, the green indicator light flashes.

⑤ **Suck-back anesthetic function:**

During the injection process, when the finger leaves the area of the Start work key, the device will automatically suck back.

⑥ **Charging method:**

After connecting the adapter to the charging box, put the host computer on the charging box. The yellow light of the main engine flashes, and the green light "breathing" on the charging seat is normal charging. To prolong battery life, charge the battery fully using the supplied charger.

8. Changing the O-Ring

Remove the old O-ring using a dental explorer. Install a new O-ring with a small amount of silicone lubricant.

9. Attention

CAUTION

1.The Mini I(Smart I) Electric Oral Anesthesia Injector is only intended for local anesthesia in Dentistry. It provides a constant speed pressure boost. The selection of anesthetic and needle shall be purchased according to doctors' clinical requirements. Any results caused by misuse of anesthetic and needle have nothing to do with this product.

2. To keep the handpiece clean, we recommend using a disposable protective sleeve. The unit is delivered with disposable sleeves to be replaced prior to use for each patient. After using, clean the handpiece and charger with clean, dry tissue.

3.The booster tube can be autoclave sterilized:

It is recommended to use type B autoclave for sterilization (sterilization parameters: sterilization temperature: 134°C (273° F) ± 2°C. Sterilization time: not less than 4min. Therecommended sterilization period :Sterilize immediately after use .Attention:After sterilization, check whether there is deformation, damage, crack and other damage, if there is damage, should stop using.

4. Store the lithium ion battery in a cool, dry and well-ventilated environment, avoiding exposure to heat. To prevent the over discharge of battery, complete a minimum of one full charge every 1 months.

5. The handpiece battery is not removable, and must be charged with the matching battery charger.

6. Storage requirements:

a. Temperature between -20°C ~ +55°C

b. Relative humidity less than 95%

c. Air pressure: 700 hPa ~ 1060 hPa (1 ATM = 1013.25 hPa)

d. Avoid contact with corrosive materials

7. Work environment

Ambient temperature: 5 °C ~ 40 °C

Relative humidity: ≤80%

Air pressure: 700 hPa ~ 1060 hPa (1 ATM = 1013.25 hPa)

6. While in use, avoid high magnetic fields, alternating current equipment, and electromagnetic interference impacting normal use.

8. While transporting and using the product, avoid strong vibration, drop, and shock.

9. If any malfunction of the device, please contact our company for maintenance instead of disassembling on your own, this would void the warranty.

10. When this product must be disposed of, follow the relevant regulations of your country.

11. Do not modify this equipment without authorization of the manufacturer

10. FCC Caution

Any Changes or modifications not expressly approved by the party responsible for compliance could void the user's authority to operate the equipment

This device complies with part 15 of the FCC Rules. Operation is subject to the following two conditions: (1) This device may not cause harmful interference, and (2) this device must accept any interference received, including interference that may cause undesired operation.





FCC RF Radiation Exposure Statement:









1. This Transmitter must not be co-located or operating in conjunction with any other antenna or transmitter.
2. This equipment complies with RF radiation exposure limits set forth for an uncontrolled environment.
3. This equipment should be installed and operated with minimum distance 20cm between the radiator & your body.

11. Device Label

Model : Mini I	
Product Name : Electric Oral Anesthesia Injector	
Power Supply : 5Vd.c., 1A (Internal battery: 3.7Vd.c., 220mAh)	FCC ID : 2AVH2EOAIMI
 SNMI1810001	 10/2018
 Shenzhen Soga Medical Equipment Co., Ltd. D906 of Yinxing technology building, No. 1301, Guan Guang Road, Xinlan community, Guanlan street, Longhua District ,ShenZhen, Guangdong, China	
	
        	

12. Label Symbols Defined

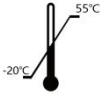
	Serial Number		Date of manufacture
	Manufacturer		Authorized representative in the European Community

	Symbol for "REFER TO INSTRUCTION MANUAL"		Product must be collected separately
	BType Equipment		Caution
	Keep dry		Fragile, handle with care
	Symbol for "CONFORMITE EUROPPENE MARK"		Temperature limit
	Federal Communications Commission		

13. Prevention of Cross-Contamination

To help prevent cross-contamination between patients, place a new protective barrier sheath on the device for each new patient. The barrier must cover the device and with the cartridge inside and then place the needle through the sheath on the top of the device connecting it to the boosting pipe.

14. Troubleshooting

1. Before using the suction load function, check the o-ring. The o-ring must be set in the front part of the plunger. If there are signs of wear, replace it following the procedure in section V – Changing the O-Ring.
2. When suction loading, the o-ring produces a negative pressure with anesthetic tube. After a week or every 24 cycles, apply a small amount of silicone lubricant to the o-ring.
3. If there is ever a system halt, put the handpiece on the charging seat. The handpiece will automatically reset to the original settings.

15. Manufacturer Warranty, Service and Support

The Mini I(Smart I) Electric Oral Anesthesia Injector is guaranteed against manufacturer defects for 1 year from date of purchase. Do not attempt to disassemble or repair the handpiece – it contains no user-serviceable parts. Contact us for a Return Manufacturer Authorization(RMA) and shipping instructions in advance.

16. Magnetic compatibility information

WARNING:

Use of this equipment adjacent to or stacked with other equipment should be avoided because it could result in improper operation. If such use is necessary, this equipment and the other equipment should be observed to verify that they are operating normally.

Use of accessories, transducers and cables other than those specified or provided by the manufacturer of this the Mini I(Smart I) I Electric Oral Anesthesia Injector could result in increased electromagnetic emissions or decreased electromagnetic immunity of this equipment and result in improper operatio

The EMISSIONS characteristics of this equipment make it suitable for use in industrial areas and hospitals . If it is used in a residential environment (for which CISPR 11 class B is normally required) this equipment might not offer adequate protection to radio-frequency communication services. The user might need to take mitigation measures, such as relocating or re-orienting the equipment.

**Guidance and manufacturer's declaration – electromagnetic immunity –
for all EQUIPMENT and SYSTEMS**

Guidance and manufacturer's declaration – electromagnetic emission		
The Mini I(Smart I) Electric Oral Anesthesia Injector is intended for use in the electromagnetic environment specified below. The customer or the user of Mini I(Smart I) I Electric Oral Anesthesia Injector should assure that it is used in such an environment.		
Emissions test	Compliance	Electromagnetic environment - guidance
RF emissions CISPR 11	Group 1	The Mini I(Smart I) Electric Oral Anesthesia Injector uses RF energy only for its internal function. There for, its RF emissions are very low and are not likely to cause any interference in nearby electronic equipment.
RF emissions CISPR 11	Class B	The Mini I(Smart I) Electric Oral Anesthesia Injector suitable for use in allestablishments, including domestic establishments and those directly connected to the public low-voltage power supply network that supplies buildings used for domestic purposes.
Harmonic emissions IEC 61000-3-2	N/A	
Voltage fluctuations flicker emissions IEC 61000-3-3	N/A	

**Guidance and manufacturer's declaration – electromagnetic immunity –
for all EQUIPMENT and SYSTEMS**

Guidance and manufacturer's declaration – electromagnetic immunity			
The Mini I(Smart I) Electric Oral Anesthesia Injector is intended for use in the electromagnetic environment specified below. The customer or the user of the Mini I(Smart I) Electric Oral Anesthesia Injector should assure that it is used in such an environment.			
Immunity test	IEC 60601 test level	Compliance level	Electromagnetic environment - guidance
Electrostatic discharge (ESD)	± 8 kV contact ± 2 kV, ± 4 kV, ± 8 kV,	± 8 kV contact	Floors should be wood, concrete or ceramic tile. If floors are covered with

Min I(Smart) User Manual

IEC 61000-4-2	± 15 kV air	± 2 kV, ± 4 kV, ± 8 kV, ± 15 kV air	synthetic material, the relative humidity should be at least 30 %.
Electrostatic transient / burst IEC 61000-4-4	± 2 kV for power supply lines ± 1 kV for input/output lines	N/A	Mains power quality should be that of a typical commercial or hospital environment.
Surge IEC 61000-4-5	± 1 kV differential mode ± 2 kV common mode	N/A	Mains power quality should be that of a typical commercial or hospital environment.
Voltage dips, short interruptions and voltage variations on power supply input lines IEC 61000-4-11	0 % UT; 0,5 cycle g) At 0°, 45°, 90°, 135°, 180°, 225°, 270° and 315° 0 % UT; 1 cycle and 70 % UT; 25/30 cycles Single phase: at 0° 0 % UT; 250/300 cycle	N/A	Mains power quality should be that of a typical commercial or hospital environment. If the user of the Mini I(Smart I) Electric Oral Anesthesia Injector requires continued operation during power mains interruptions, it is recommended that the Mini I(Smart I) Electric Oral Anesthesia Injector be powered from an uninterruptible power supply or a battery.
Power frequency (50/60 Hz) magnetic field IEC 61000-4-8	30 A/m	30 A/m	Power frequency magnetic fields should be at levels characteristic of a typical location in a typical commercial or hospital environment.
NOTE U_T is the a. c. mains voltage prior to application of the test level.			

**Guidance and manufacturer's declaration – electromagnetic immunity –
for EQUIPMENT and SYSTEM**

Guidance and manufacturer's declaration – electromagnetic immunity			
The Mini I(Smart I) Electric Oral Anesthesia Injector is intended for use in the electromagnetic environment specified below. The customer or the user of the Mini I(Smart I) Electric Oral Anesthesia Injector should assure that it is used in such an environment.			
Immunity test	IEC 60601 test level	Compliance level	Electromagnetic environment - guidance
Conducted RF IEC 61000-4-6	3 Vrms 150 kHz to 80 MHz	N/A	Portable and mobile RF communications equipment should be used no closer to any part of the Mini I(Smart I) Electric Oral Anesthesia Injector, including cables, than the recommended separation distance calculated from the equation applicable to the frequency of the transmitter. Recommended separation distance $d = \left[\frac{3.5}{V_1} \right] \sqrt{P}$ $d = \left[\frac{12}{V_2} \right] \sqrt{P}$
	6 V in ISM and amateur radio bands between 0,15 MHz and 80 MHz		
Radiated RF IEC 61000-4-3	10 V/m 80 MHz to 2.7 GHz	10 V/m 80 MHz to 2.7 GHz	$d = \left[\frac{3.5}{E_1} \right] \sqrt{P} \quad 80 \text{ MHz to } 800 \text{ MHz}$ $d = \left[\frac{7}{E_1} \right] \sqrt{P} \quad 800 \text{ MHz to } 2.7 \text{ GHz}$ <p>where p is the maximum output power rating of the transmitter in watts (W) according to the transmitter manufacturer and d is the recommended separation distance in metres (m).^b</p> <p>Field strengths from fixed RF transmitters, as determined by an electromagnetic site survey,^a should be less than the compliance level in each frequency range.^b</p> <p>Interference may occur in the vicinity of equipment marked with the following symbol:</p>
	385MHz-5785MHz Test specifications for ENCLOSURE PORT IMMUNITY to RF wireless communication equipment (Refer to table 9 of IEC 60601-1-2:2014)	385MHz-5785MHz Test specifications for ENCLOSURE PORT IMMUNITY to RF wireless communication equipment (Refer to table 9 of IEC 60601-1-2:2014)	

			
--	--	--	--

NOTE 1 At 80 MHz and 800 MHz, the higher frequency range applies.

NOTE 2 These guidelines may not apply in all situations. Electromagnetic is affected by absorption and reflection from structures, objects and people.

^a The ISM (industrial, scientific and medical) bands between 150 kHz and 80 MHz are 6,765 MHz to 6,795 MHz; 13,553 MHz to 13,567 MHz; 26,957 MHz to 27,283 MHz; and 40,66 MHz to 40,70 MHz. The amateur radio bands between 0,15 MHz and 80 MHz are 1,8 MHz to 2,0 MHz, 3,5 MHz to 4,0 MHz, 5,3 MHz to 5,4 MHz, 7 MHz to 7,3 MHz, 10,1 MHz to 10,15 MHz, 14 MHz to 14,2 MHz, 18,07 MHz to 18,17 MHz, 21,0 MHz to 21,4 MHz, 24,89 MHz to 24,99 MHz, 28,0 MHz to 29,7 MHz and 50,0 MHz to 54,0 MHz.

^b Field strengths from fixed transmitters, such as base stations for radio (cellular/cordless) telephones and land mobile radios, amateur radio, AM and FM radio broadcast and TV broadcast cannot be predicted theoretically with accuracy. To assess the electromagnetic environment due to fixed RF transmitters, an electromagnetic site survey should be considered. If the measured field strength in the location in which the Mini I(Smart I) Electric Oral Anesthesia Injector is used exceeds the applicable RF compliance level above, the Mini I(Smart I) Electric Oral Anesthesia Injector should be observed to verify normal operation. If abnormal performance is observed, additional measures may be necessary, such as reorienting or relocating the Mini I(Smart I) Electric Oral Anesthesia Injector.

^c Over the frequency range 150 kHz to 80 MHz, field strengths should be less than 3V/m.

Recommended separation distances between portable and mobile RF communications equipment and the EQUIPMENT or SYSTEM - for EQUIPMENT and SYSTEMS

Recommended separation distances between portable and mobile RF communications equipment and the Mini I(Smart I) Electric Oral Anesthesia Injector

The Mini I(Smart I) Electric Oral Anesthesia Injector is intended for use in an electromagnetic environment in which radiated RF disturbances are controlled. The customer or the user of the Mini I(Smart I) Electric Oral Anesthesia Injector can help prevent electromagnetic interference by maintaining a minimum distance between portable and mobile RF communications equipment (transmitters) and the Mini I (Smart I)Electric Oral Anesthesia Injector as recommended below, according to the maximum output power of the communications equipment

Rated maximum output of transmitter W	Separation distance according to frequency of transmitter m			
	150 kHz to 80 MHz outside ISM and amateur radio bands $d = [\frac{3.5}{V_1}] \sqrt{P}$	150 kHz to 80 MHz in ISM and amateur radio bands $d = [\frac{12}{V_2}] \sqrt{P}$	80 MHz to 800 MHz $d = [\frac{3.5}{E_1}] \sqrt{P}$	800 MHz to 2.7 GHz $d = [\frac{7}{E_1}] \sqrt{P}$
0.01	0.12	0.20	0.035	0.07
0.1	0.38	0.63	0.11	0.22
1	1.2	2.00	0.35	0.70
10	3.8	6.32	1.10	2.21
100	12	20.00	35	70

For transmitters rated at a maximum output power not listed above the recommended separation distance d in metres (m) can be estimated using the equation applicable to the frequency of the transmitter, where P is the maximum output power rating of the transmitter in watts (W) according to the transmitter manufacturer.

NOTE 1 At 80 MHz and 800 MHz, the separation distance for the higher frequency range applies.

NOTE 2 These guidelines may not apply in all situations. Electromagnetic propagation is affected by absorption and reflection from structures, objects and people.